

INTERNO4

Hidden marbles



Our values/

Made in Italy

Selezioniamo le migliori materie prime e, secondo canoni estetici e funzionali, le trasformiamo in prodotti che interpretano con creatività il gusto italiano. Utilizziamo in uguale misura passione e tecnologia, cura del dettaglio e precisione, chimica e cultura, estetica e attenzione all'ambiente. Per noi Made in Italy è racchiudere tutto questo in ogni singolo prodotto.

Made in Italy

We pick the very best raw materials and we follow aesthetics and functional criteria to turn them into products embodying Italian taste and excellence. We sharply combine passion and technology, creativity and accuracy, science and culture, and environmental friendliness. To all of us, Made in Italy means gathering these features into every single product.

Greenthinking

Recuperiamo il 100% dell'acqua, autoproduciamo il 65% dell'energia, differenziamo il 98% dei rifiuti. Siamo stati i primi del settore ceramico a ottenere la certificazione PEF e tra i primi a guadagnarci l'EPD, la FDES e la HPDC. La maggior parte dei nostri prodotti è compatibile con lo standard LEED - Leadership in Energy and Environmental Design. Questo per noi è Greenthinking: un promessa molto seria, un impegno quotidiano.

Greenthinking

We recycle 100% of our water, produce 65% of our energy, separate 98% of our waste. We were the first company in the ceramic industry to obtain PEF certification and were among the first to earn the EPD, the FDES, and the HPDC certifications. The majority of our products comply with the LEED - Leadership in Energy and Environmental Design - standard. Greenthinking implies a solemn promise, an everyday commitment.

GRES PORCELLANATO
PORCELAIN STONEWARE

Effetto marmo
Marble effect

INTERNO4

Hidden marbles



entrata





ISPIRAZIONE/ INSPIRATION

Tesori privati

Ingressi di dimore e palazzi di prestigio raccontano un'architettura modernista, compositiva, simmetrica, nobile: quella di Milano. Marmi lustrati e colorati segnano zone, livelli e scorci di spazi di attesa ormai iconici. Una delle migliori eredità degli anni '30 e '50 del Novecento, ripresa anche dal mondo del fashion e del design, con Interno4, si dona all'architettura contemporanea.

Private treasures

The entrances to dwellings and to prestigious palazzos recount a modernist, compositive, symmetrical and noble architecture: that of Milan. Glossy and colourful marbles distinguish areas, levels and glimpses of now iconic waiting spaces. With Interno4, one of the best legacies of the 1930s and 50s, also mirrored in the world of fashion and design is being lent to contemporary architecture.



INDOOR

120x278 6 mm
80x160 9 mm
120x120 9 mm
60x120 9 mm
30x120 9 mm
80x80 9 mm
60x60 9 mm

7
FORMATI/
SIZES

2
SPESSORI/
THICKNESSES

Formati e spessori

Con sette formati e due spessori, la linea Interno4 effetto marmo libera la composizione decorativa, permette giochi di equilibrio e incastro ispirati allo slancio maestoso degli interni signorili novecenteschi. L'ampiezza della lastra 120x278 in 6mm dà respiro alle grafiche della collezione, mentre i nuovi formati 80x160 e 80x80 esprimono il miglior compromesso tra continuità grafica e facilità di posa. Le forme geometriche dei mosaici 30x30 e dei mosaici rombi, suggeriscono composizioni eterogenee.

Sizes and thicknesses

With seven sizes and two thicknesses, the marble look Interno4 line sets the decorative composition free, allowing games of balances and insets inspired by the majestic momentum of 20th Century stately interiors. The breadth of the 6 mm-thick 120x278 slab leaves plenty of room for the graphics in the collection, while the new 80x160 and 80x80 sizes express the best compromise between graphic continuity and easy installation. The geometrical shapes of the 30x30 mosaics and of the Rombi mosaics make for heterogeneous compositions.



Colori e superfici

Colori minerali decisi arrivano su pavimenti e rivestimenti in ceramica per progetti di pregio, in versione lucida o matt. Il color ruggine di Carnico Brera, le venature cipria di Calacatta San Babila, i guizzi intensi di Breccia Tortona e il rigore di Renoir Isola raccontano con sapienza il lavoro scenografico di pregiatissimi marmi tra gli anni '30 e '50. Il fondo Palladiana, Light o Dark, accentua il tocco retrò nel formato 120x120.

6 COLORI/ COLORS

2 SUPERFICI/ SURFACES

Colors and surfaces

Strong mineral colors, in glossy or matt version, take over ceramic floors and walls for impactful projects. The rust color of Carnico Brera, the powdery veins of Calacatta San Babila, the intense flashes of Breccia Tortona and the rigor of Renoir Isola describe the scenographic work of refined marbles used between the 30's and the 50's. The Light or Dark Palladiana background, 120x120cm, emphasizes Interno4's retro touch.

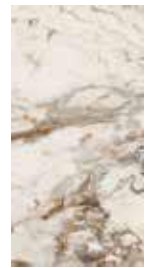

Breccia
Tortona



Renoir
Isola



Calacatta
San Babila



Carnico
Brera



Palladiana
Light



Palladiana
Dark

breccia tortona

120x278 (48"x110") - 120x120 (48"x48")

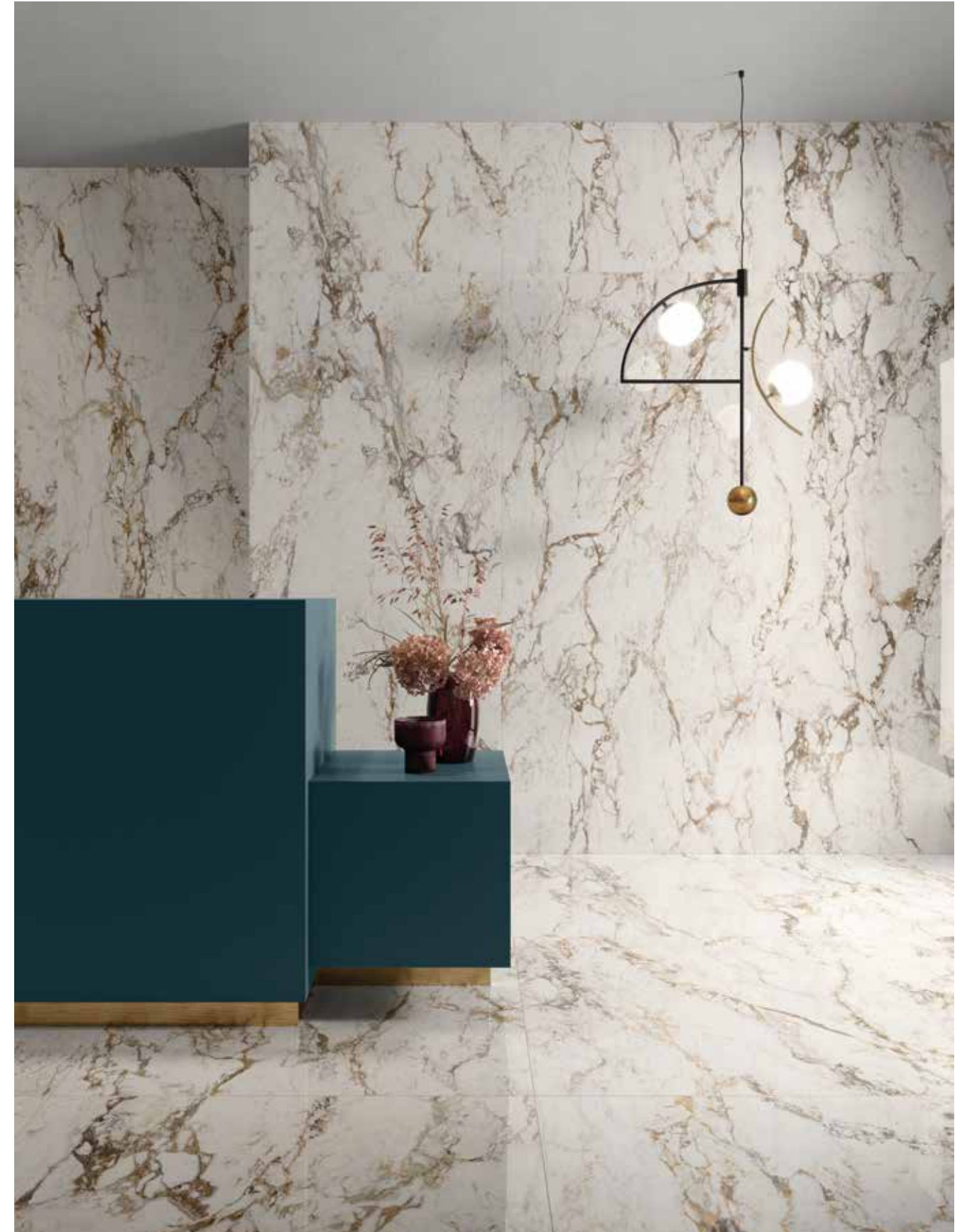

120x120 (48"x48") - MOSAICO ROMBI 30,5x35,2 (12¹/₁₆"x13⁷/₈") -
COPRISPIGOLO 1,4x60 (3³/₆₄"x24") - ANGOLARE 1,4x1,4 (3³/₆₄"x3³/₆₄")



120x278 (48"x110")

interno4 breccia tortona



120x278 (48"x110") -
120x120 (48"x48")

interno4 breccia tortona

carnico brera

120x278 (48"x110") - 120x120 (48"x48")

ELEMENTS DESIGN BEIGE
120x278 (48"x110")



120x120 (48"x48")



interno4 carnico brera



interno4 carnico brera

120x278 (48"x110") - 120x120 (48"x48") - 60x120 (24"x48")

ELEMENTS DESIGN BEIGE
120x278 (48"x110")

120x120 (48"x48") - MOSAICO ROMBI 30,5x35,2 (12^{1/16}"x13^{7/8}")

calacatta san babila

120x278 (48"x110") - 120x120 (48"x48")





120x120 (48"x48") - MOSAICO ROMBI 30,5x35,2 (12¹/₁₆"x13⁷/₈") -
COPRISPIGOLO 1x90 (26¹/₆₄"x36") - ANGOLARE 1x1 (26¹/₆₄"x26¹/₆₄")

120x278 (48"x110")

120X278 (48"x110") - 80x160 (32"x64")



interno4 calacatta san babila

renoir isola

120x278 (48"x110") - 80x80 (32"x32")

ELEMENTS DESIGN BLACK
120x120 (48"x48")

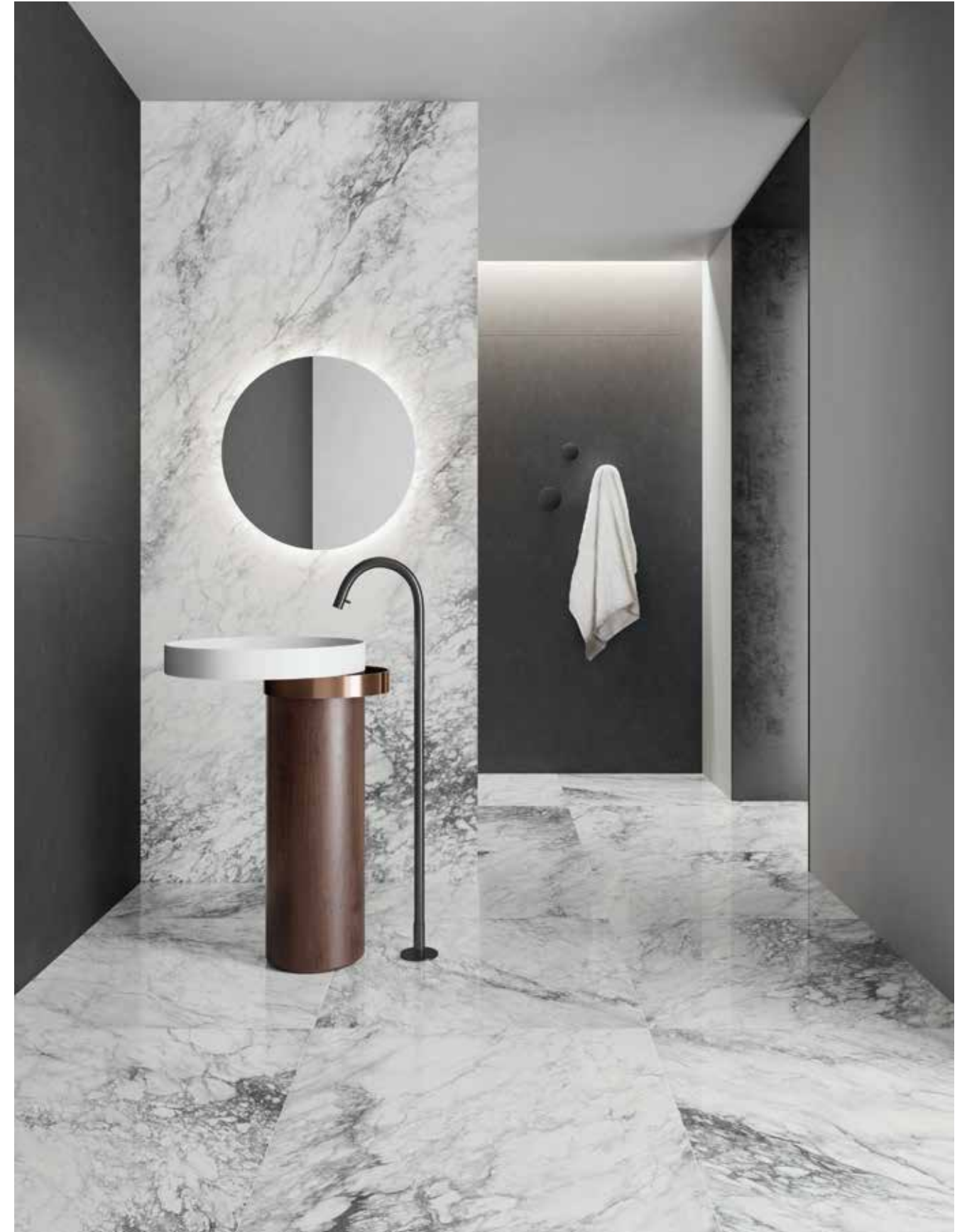

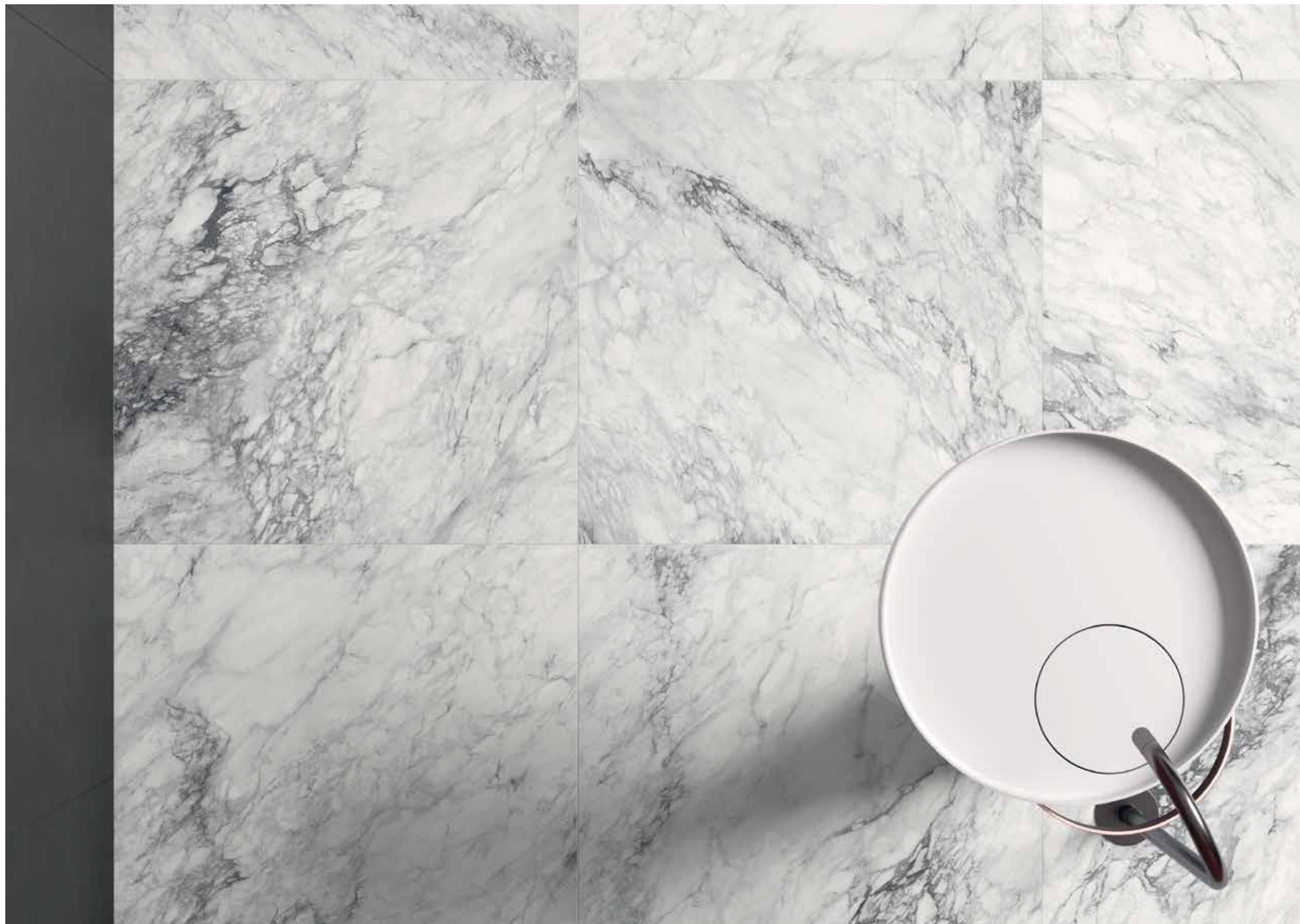

80x80 (32"x32")
ELEMENTS DESIGN BLACK
120x120 (48"x48")

interno4 renoir isola



80x160 (32"x64") - PIATTO DOCCIA FILOPAVIMENTO / SHOWER
TRAY FLOOR LEVEL HOME DECOR 90x160 (36"x64")

ELEMENTS DESIGN BLACK
120x120 (48"x48")

80x80 (32"x32") -
PALLADIANA LIGHT 120x120 (48"x48")

ELEMENTS DESIGN BLACK
120x120 (48"x48")



palladiana

PALLADIANA LIGHT
120x120 (48"x48")

E. LUX PORT LAURENT
120x278 (48"x110")

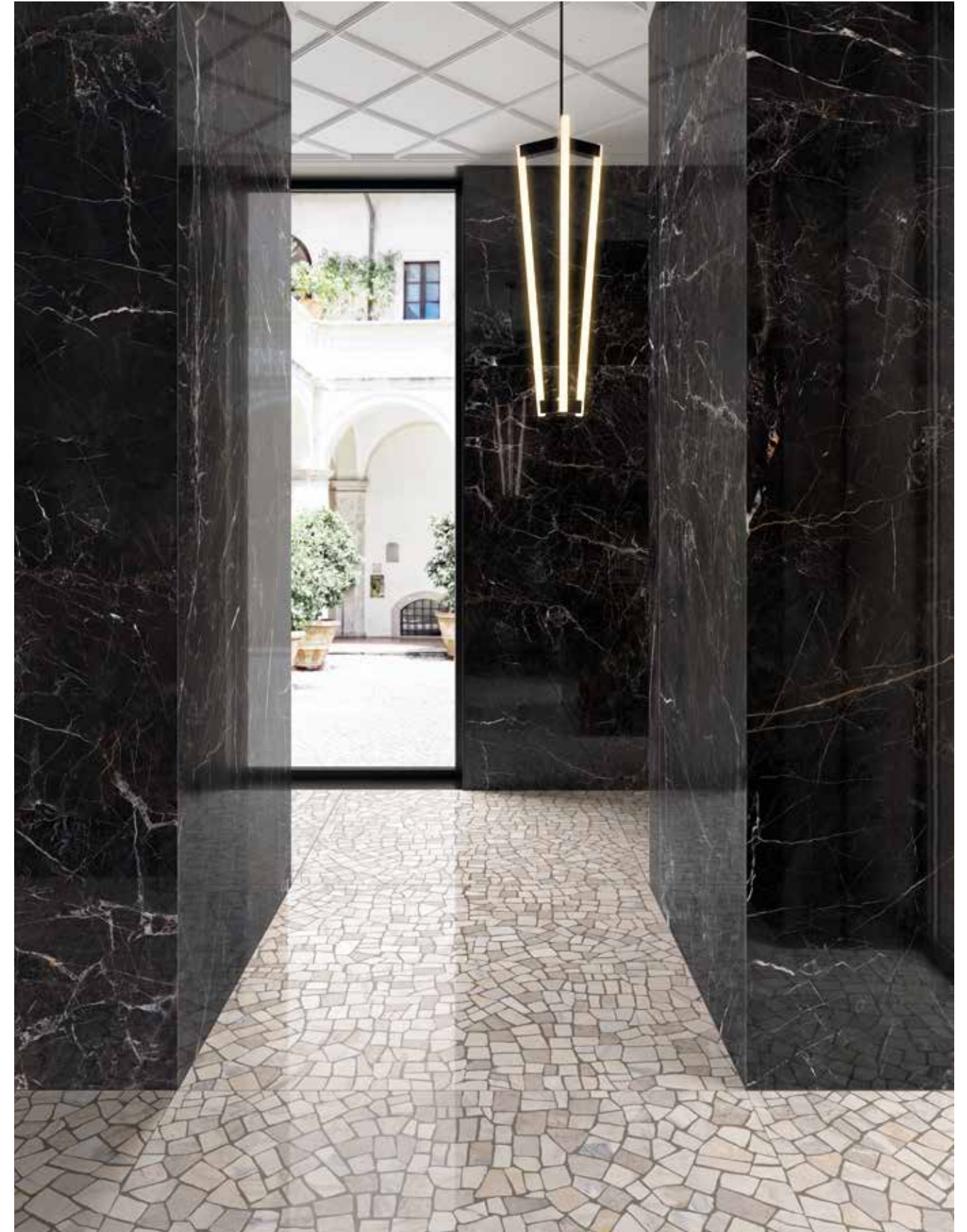



PALLADIANA LIGHT
120x120 (48"x48")

E. LUX PORT LAURENT
120x278 (48"x110")



PALLADIANA DARK
120x120 (48"x48")

PALLADIANA DARK
120x120 (48"x48")



interno4 palladiana

HOME DECOR



LAVELLO A COLONNA
COLUMN SINK



DISPONIBILE IN / AVAILABLE IN
50x50x85 cm

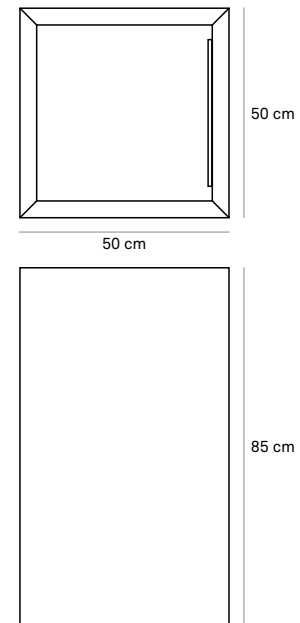

LAVELLO DA APPOGGIO
COUNTERTOP SINK



DISPONIBILE IN / AVAILABLE IN
35x50x8,5 cm

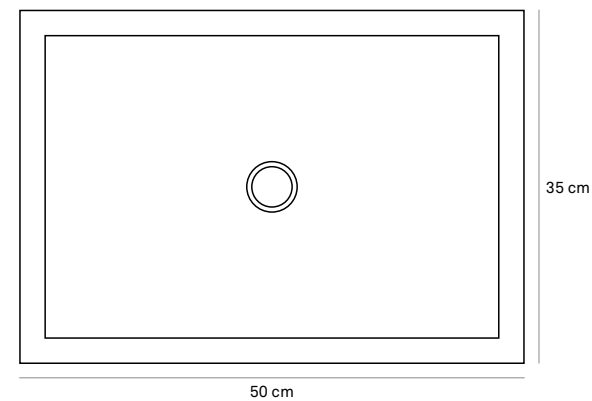

DISPONIBILE IN / AVAILABLE IN
50x120x9 cm
50x160x9 cm

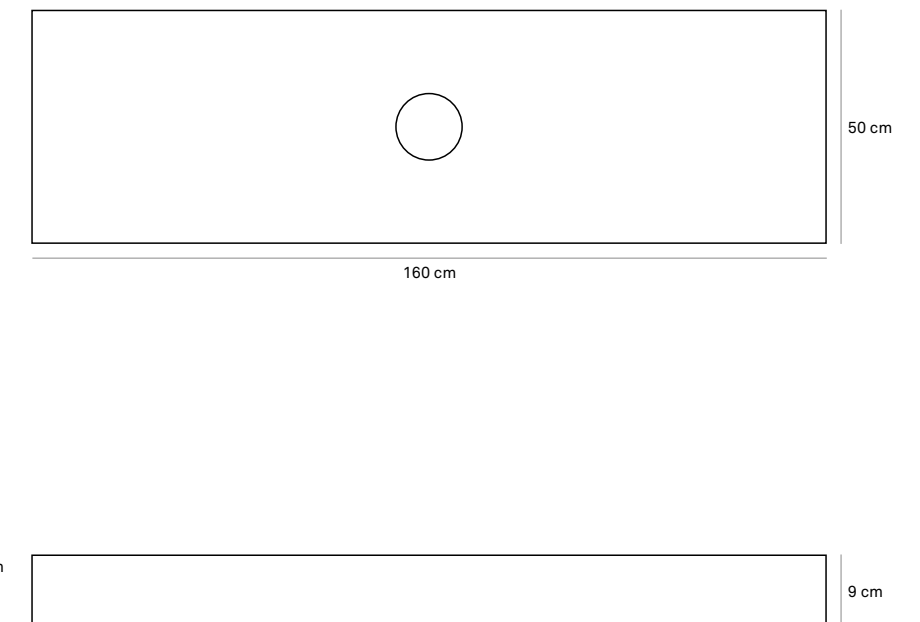

HOME DECOR



PIATTO DOCCIA*
SHOWER TRAY



DISPONIBILE IN / AVAILABLE IN

80x120 cm
80x135 cm
90x135 cm
90x160 cm

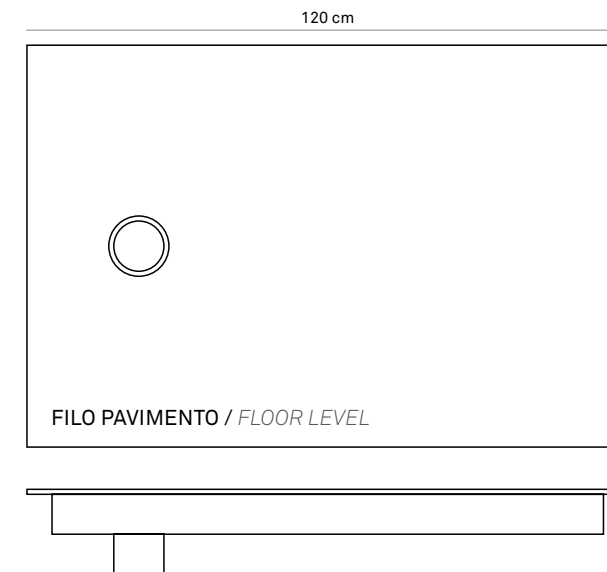

DISPONIBILE IN / AVAILABLE IN

80x120x4 cm
80x135x4 cm
90x135x4 cm
90x160x4 cm

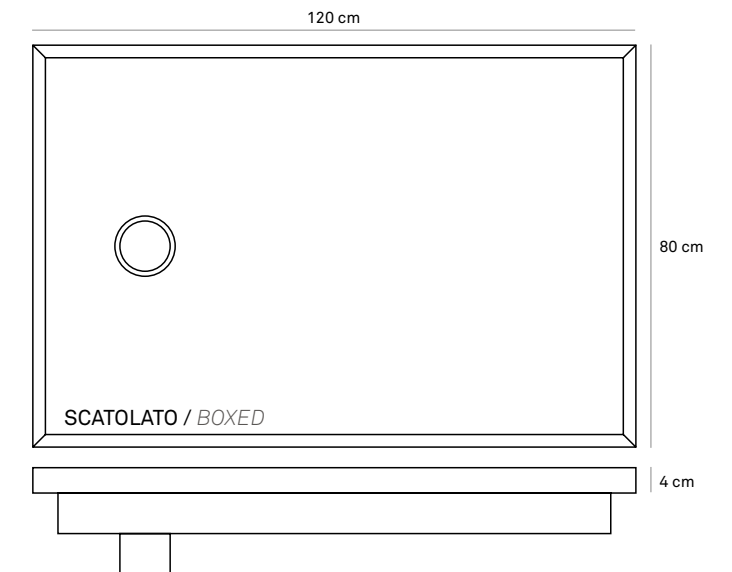

TAVOLINO CIRCOLARE
CIRCULAR TABLE



DISPONIBILE IN / AVAILABLE IN

Ø 42 cm H 50 cm
Ø 58 cm H 50 cm
Ø 73 cm H 39 cm

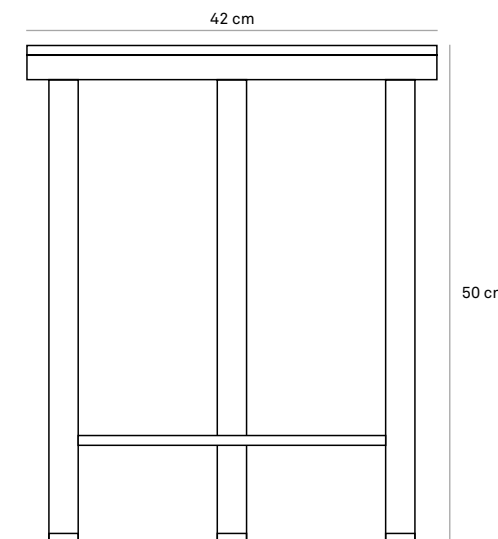

IT_

***Attenzione.** Per ottenere una superficie antiscivolo nel piatto doccia è necessario stendere un tappeto idoneo ad assicurare una presa sicura del piede in presenza di acqua.

EN_

***Warning.** To obtain a non-slip surface in the shower tray it is necessary to lay down a carpet suitable to ensure a secure grip of the foot in the presence of water.

HOME DECOR



TAVOLO RETTANGOLARE
RECTANGULAR TABLE



DISPONIBILE IN / AVAILABLE IN
95x200x75 cm



DISPONIBILE IN / AVAILABLE IN
95x175x75 cm

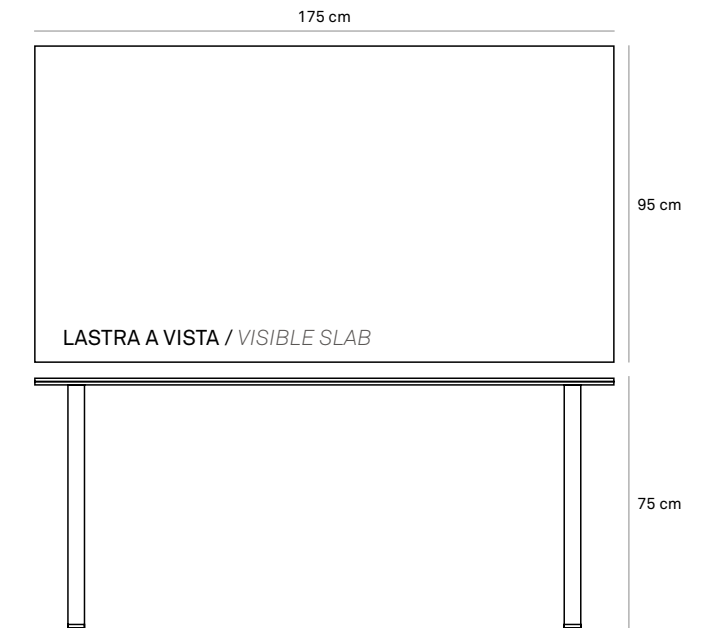

TAVOLO PLUS ATELIER
PLUS ATELIER TABLE

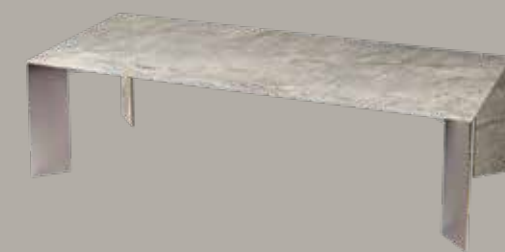

PERSONALIZZABILE IN DIMENSIONE E COLORE / CUSTOMIZABLE IN SIZE AND COLOR

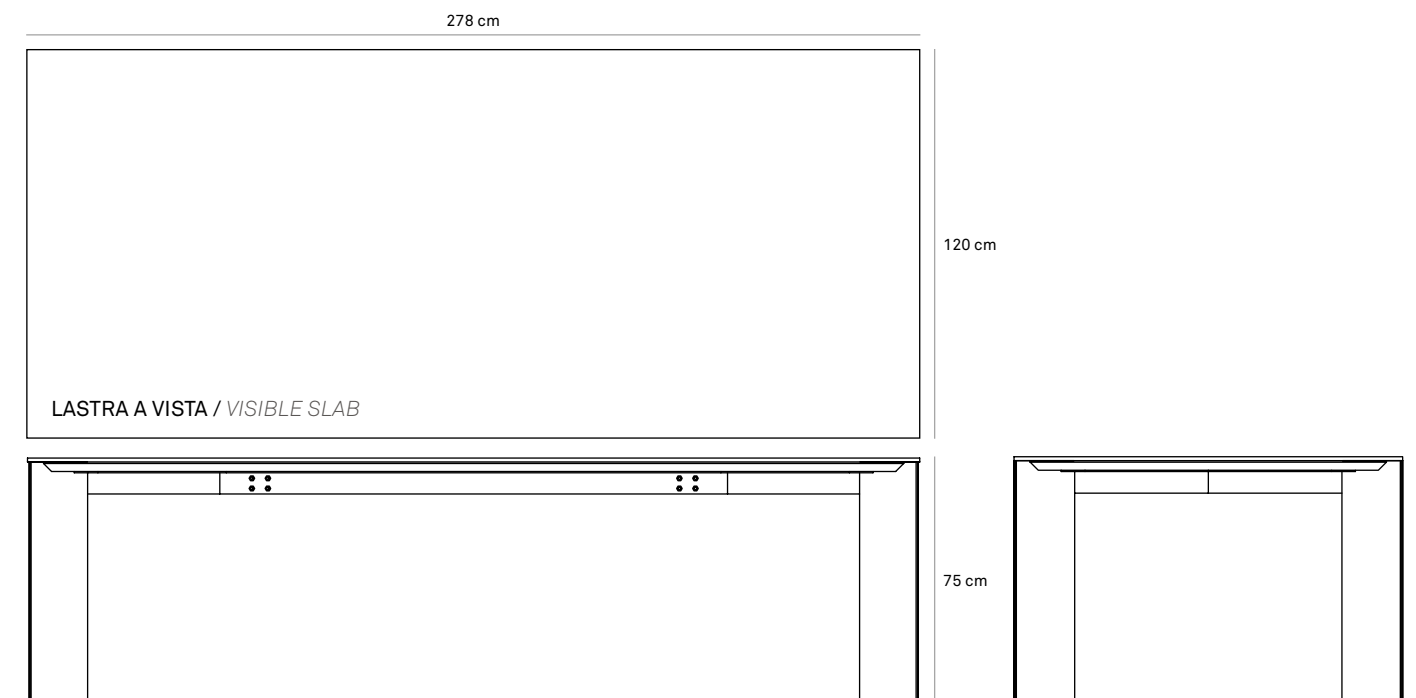

INTERNO4

SPECIFICHE TECNICHE/ TECHNICAL FEATURES

GRES PORCELLANATO TUTTA MASSA UGL/GL
FULL-BODY PORCELAIN UGL/GL

SPESSORI
THICKNESSES

6 mm (120x278)

9 mm (80x160 - 120x120 - 60x120 - 30x120 - 80x80 - 60x60)

STONALIZZAZIONE
SHADING



V2



V3

CLASSIFICAZIONE ANTISDRUCCIOLO
ASSESSMENT OF SLIP RESISTANCE

DIN 51130 R9

DIN 51097 A

COF Conforme/*Compliant*

DCOF Conforme/*Compliant*

PENDULUM + 36 PTV 96 -

GRES PORCELLANATO /
PORCELAIN STONEWARE



INATTACCABILE DA ACIDI /
NOT ATTACKED BY ACIDS



FACILMENTE PULIBILE /
EASY TO CLEAN



ANTISDRUCCIOLO /
ANTI-SLIP

per ambienti bagnati e outdoor /
for outdoor and wet environments



NON REAGISCE AL FUOCO /
DOES NOT REACT TO FIRE

non emette fumi in caso di incendio /
does not release fumes in case of fire



RESISTENTE A GELO E SHOCK TERMICI /
RESISTANT TO FROST AND SUDDEN THERMAL CHANGES



RESISTENTE A SFORZI ED ABRASIONI /
RESISTANT TO STRESSES AND ABRASION

500 Kg/cm² di pressatura meccanica e cottura a 1.250°C /
500 kg/cm² of mechanical pressing and firing at 1250°C



STABILE CROMATICAMENTE /
CHROMATICALLY FAST

inalterabile da agenti atmosferici e smog /
unchanged by weather agents and smog



ASSORBIMENTO H₂O NULLO /
NULL H₂O ABSORPTION

GREENTHINKING /
GREENTHINKING



100% ACQUE REFLUE RECUPERATE /
100% RECOVERED WASTE WATER



**98% RIFIUTI AVVIATI A
RACCOLTA DIFFERENZIATA /**
98% WASTE SENT TO SEPARATE COLLECTION



100% PALLET FAO /
100% FAO PALLETS



100% SCARTI CRUDI RECUPERATI /
100% RECOVERED RAW SCRAPS



**ENERGIA AUTO-PRODOTTA DA
FOTOVOLTAICO /**
ENERGY SELF-PRODUCED BY PV PLANT



*** + 5.000.000 L = 3.000.000** 
**ACQUE DI PROCESSO DA ALTRI
STABILIMENTI /**
PROCESS WATER FROM OTHER FACTORIES



*** 18.408 t = 570** 

**MATERIE PRIME NON ESTRATTE
GRAZIE AL RECUPERO DI SCARTI /**
NON-EXTRACTED RAW MATERIALS THANKS TO THE
RECOVERY OF SCRAPS



*** + 24.000 MWh/year = 185.000** 
**84% ENERGIA AUTO PRODOTTA DA IMPIANTI
DI COGENERAZIONE /**
84% ENERGY SELF-PRODUCED BY COGENERATION PLANTS

BRECCIA TORTONA

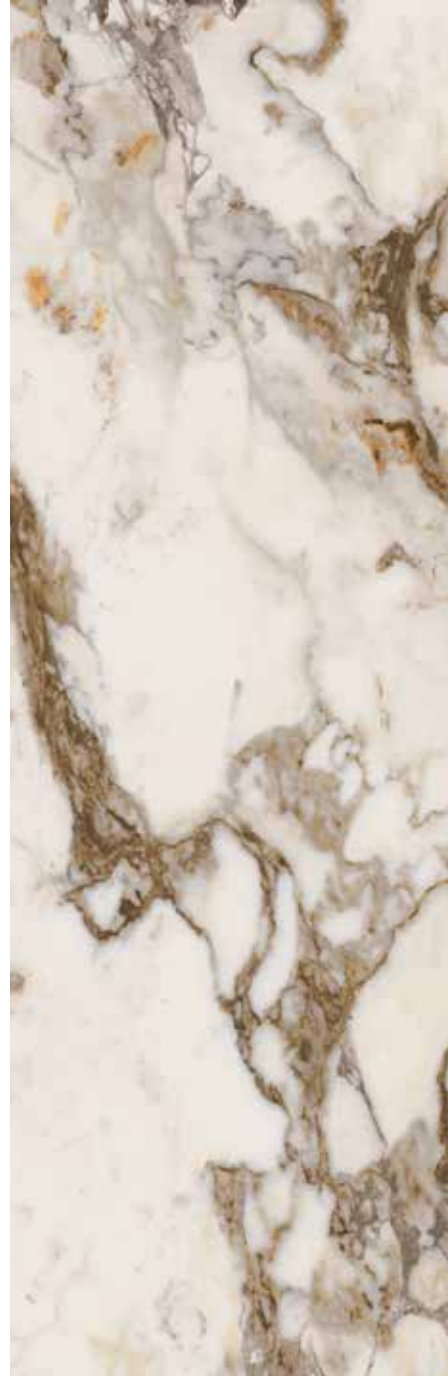

CARNICO BRERA



CALACATTA SAN BABILA



RENOIR ISOLA



PALLADIANA LIGHT



PALLADIANA DARK



V2 - V3

STONALIZZAZIONE/
SHADING

BRECCIA TORTONA V2



CARNICO BRERA V3



CALACATTA SAN BABILA V2

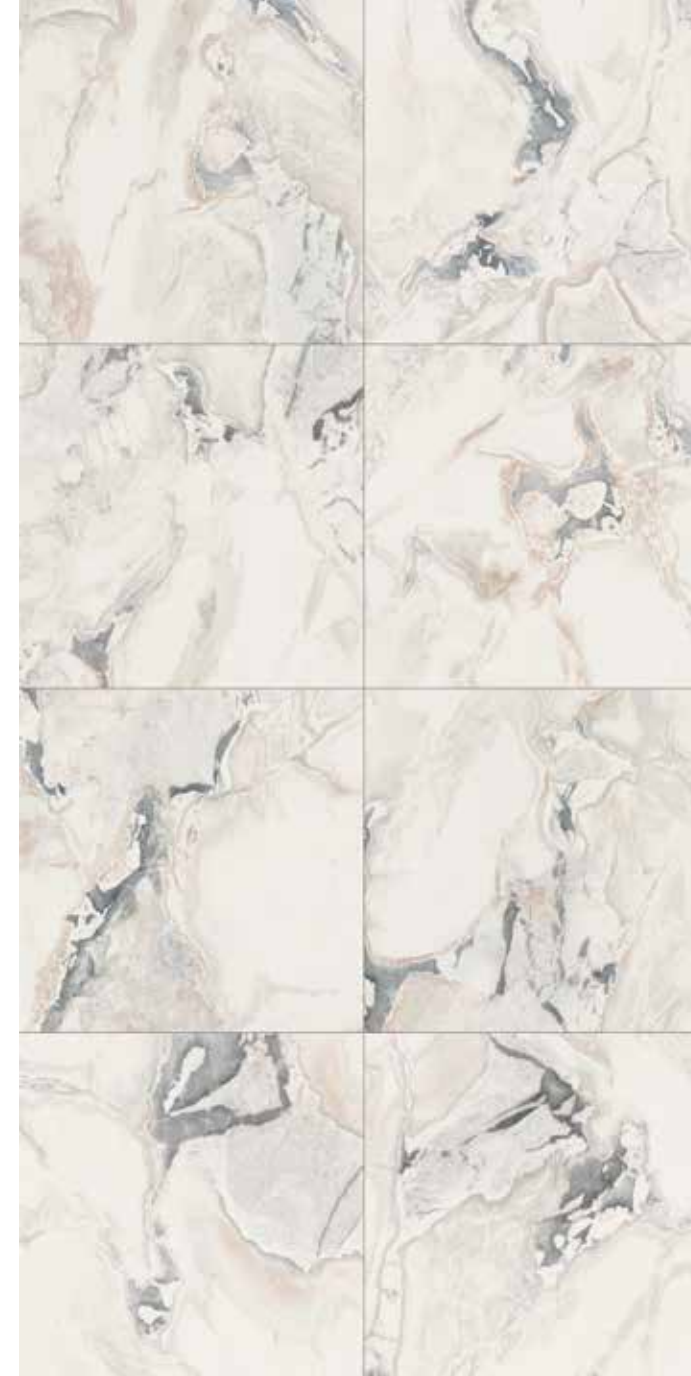

RENOIR ISOLA V2

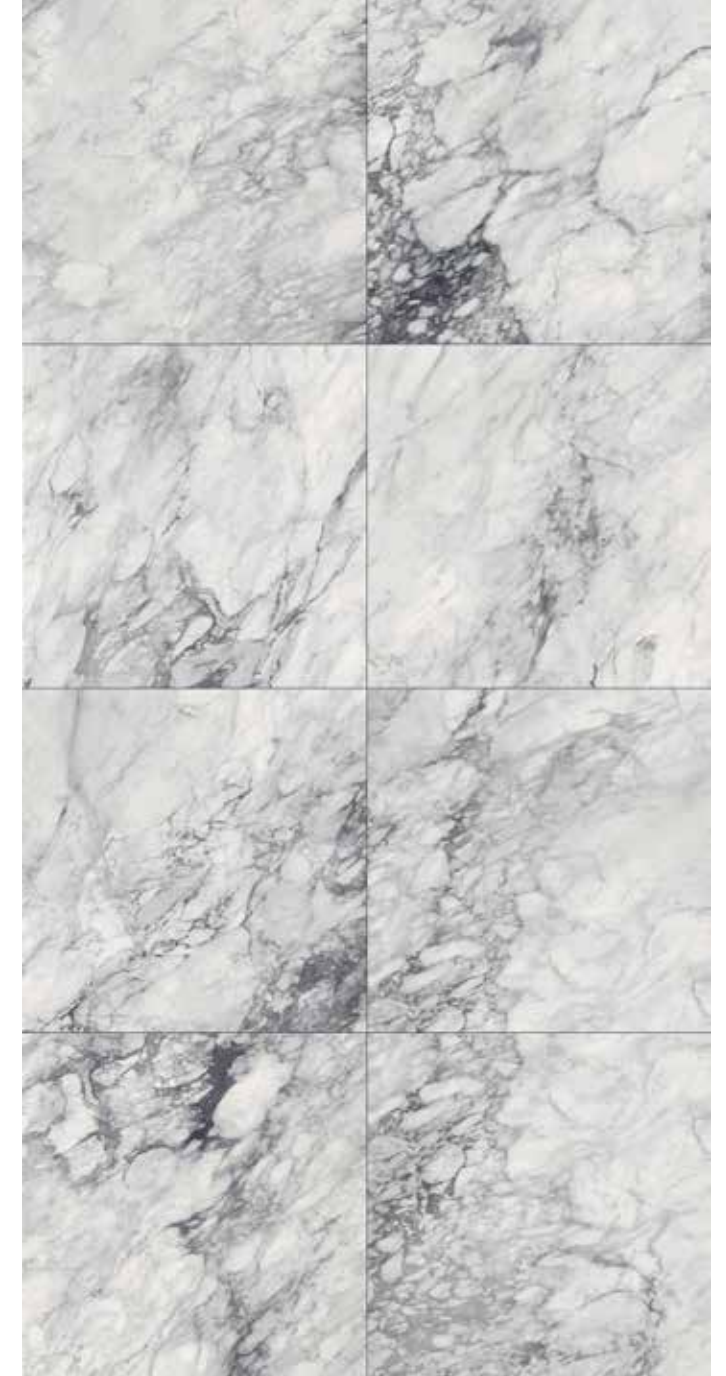

specs & tech

PALLADIANA LIGHT **V2**

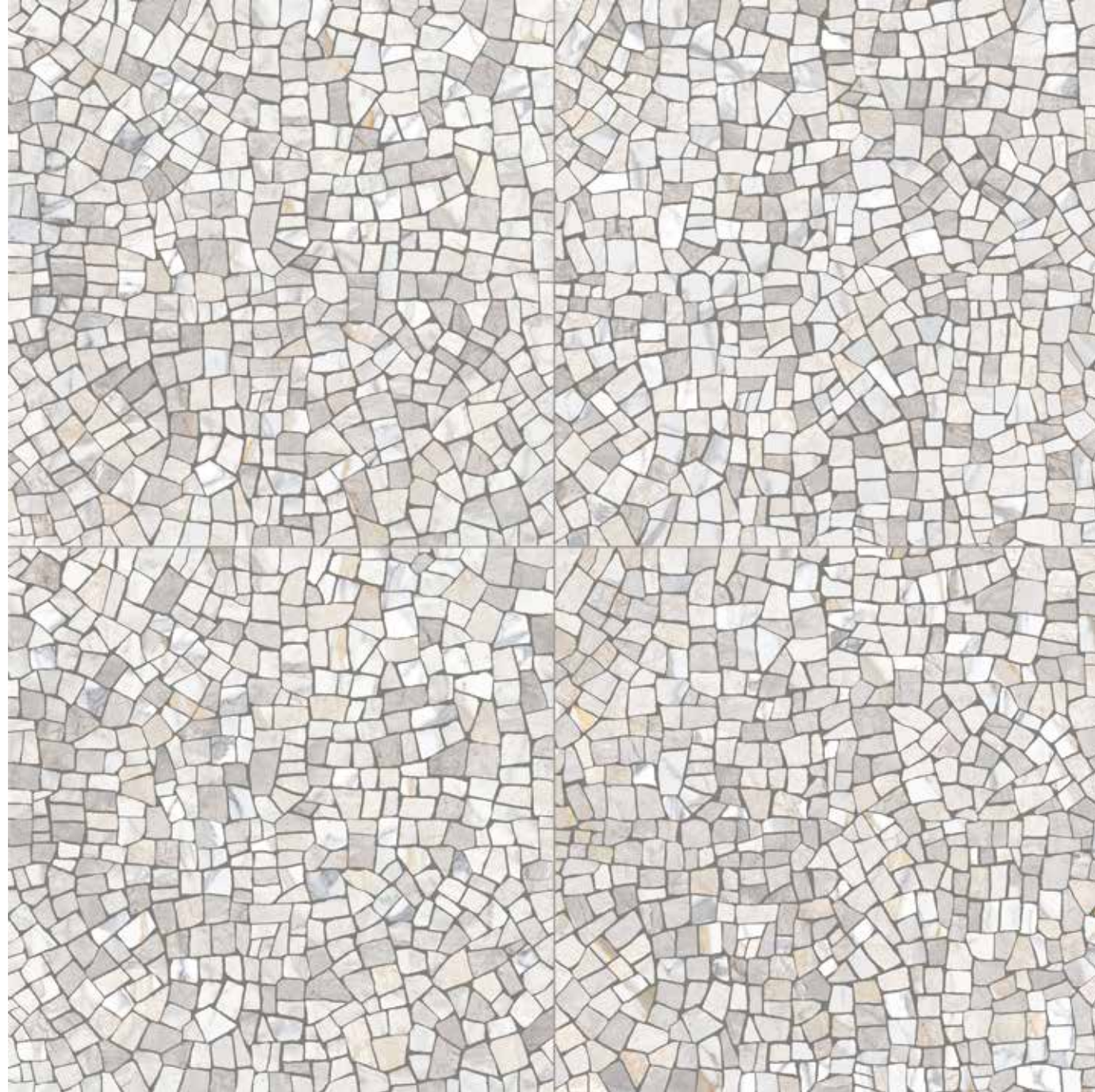

PALLADIANA DARK **V2**

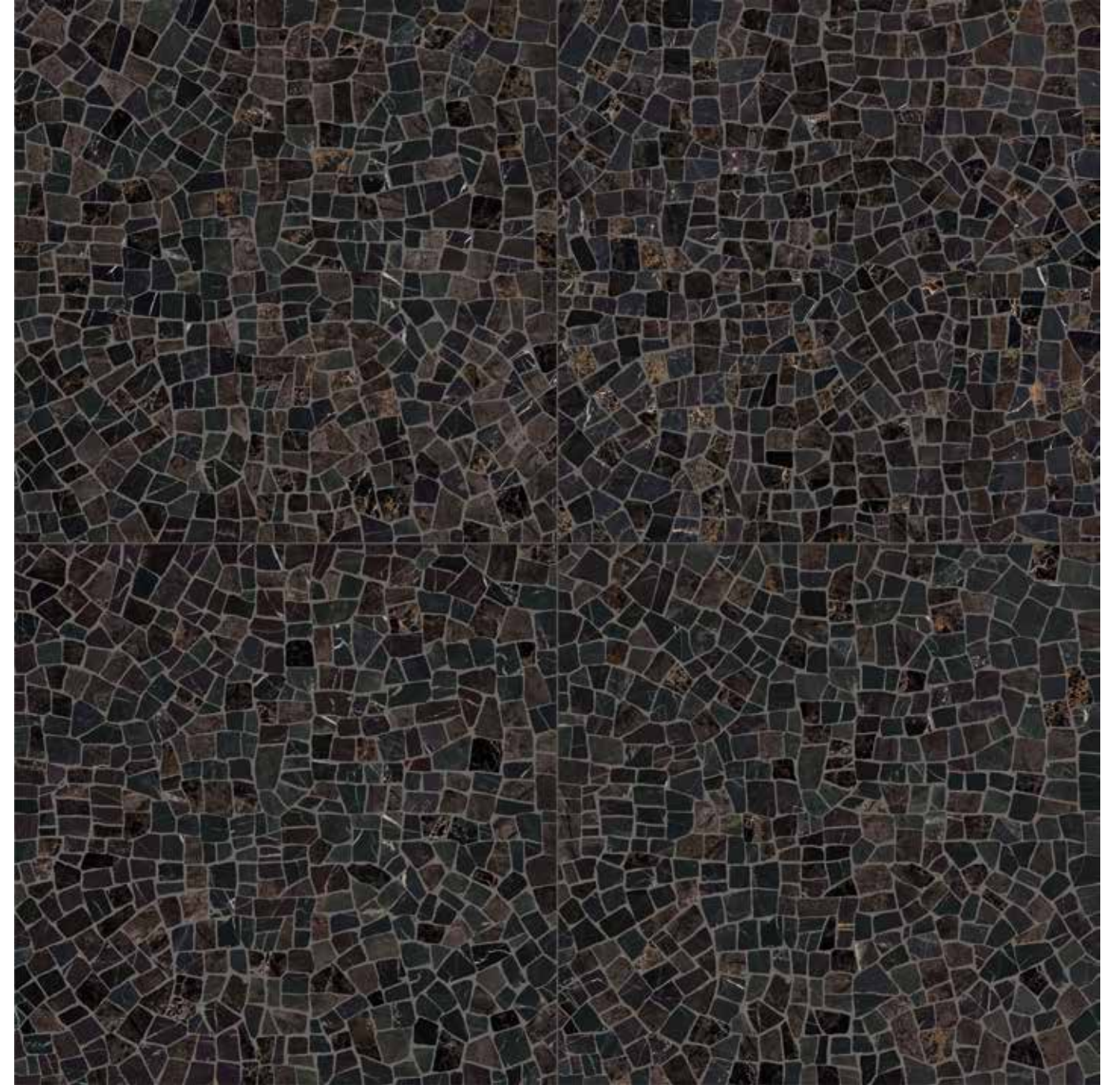

7 FORMATI/ SIZES

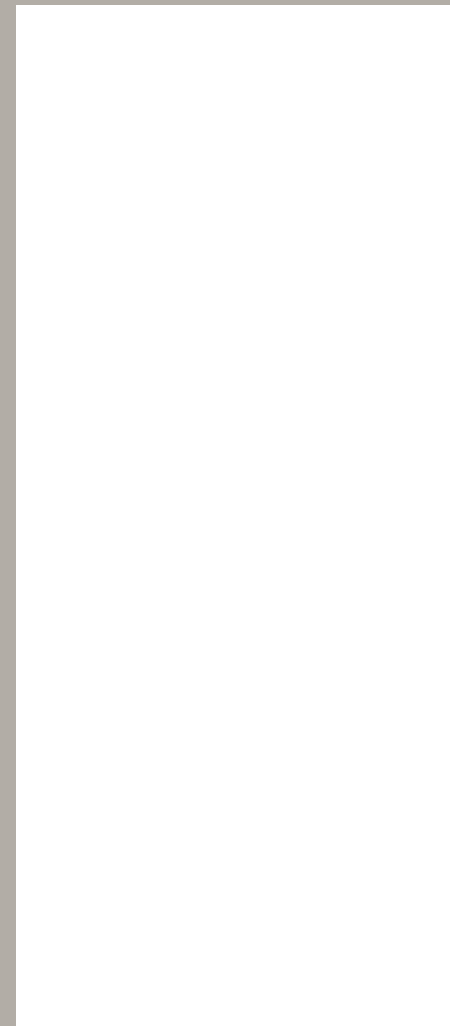

◆ 120x278 (48"x110") RT 6 mm

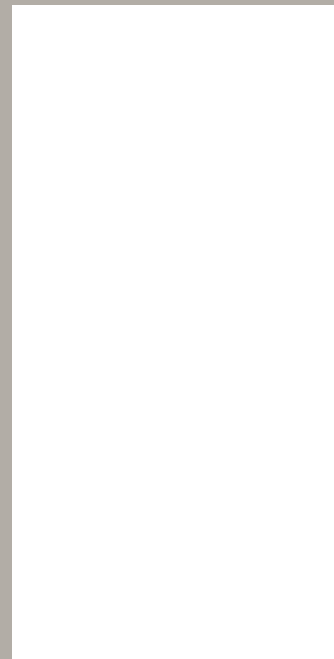

◆ 80x160 (32"x64") RT 9 mm

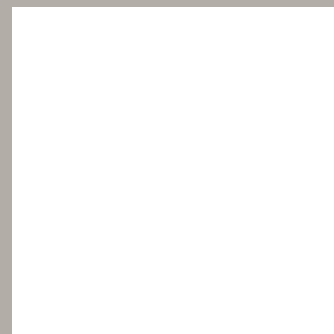

●◆ 80x80 (32"x32") RT 9 mm

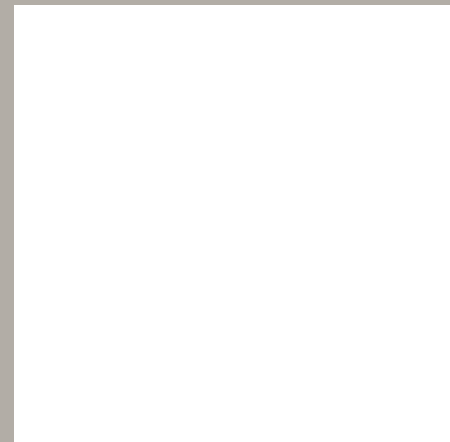

◆ 120x120 (48"x48") RT 9 mm

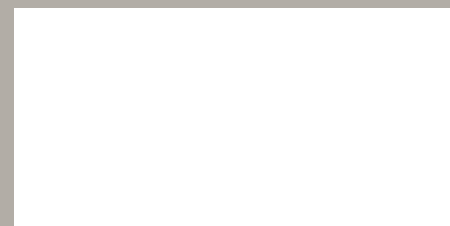

●◆ 60x120 (24"x48") RT 9 mm



◆ 30x120 (12"x48") RT 9 mm

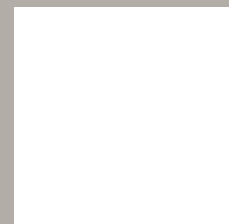

◆ 60x60 (24"x24") RT 9 mm

● Natural R9 | ◆ Lappato

6 DECORI/ DECORS

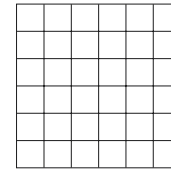

MOSAICO ◆ 30x30 (12"x12") RT 9 mm
(TESSERE: 4,8x4,8 - 17/8"x17/8")



BRECCIA TORTONA



CARNICO BRERA



CALACATTA SAN BABILA



RENOIR ISOLA

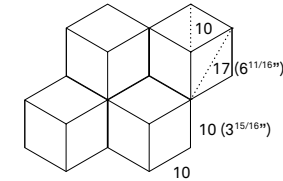

MOSAICO ROMBI
◆ 30,5x35,2 (12^{1/16}"x13^{7/8}") RT 9 mm



BRECCIA TORTONA



CARNICO BRERA



CALACATTA SAN BABILA



RENOIR ISOLA

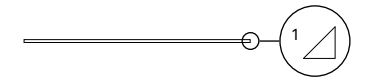

COPRISPIGOLO*
◆ 1x90 (26/64"x36") RT 6 mm



ANGOLARE COPRISPIGOLO*
◆ 1x1 (26/64"x26/64") RT 6 mm

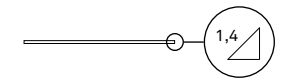

COPRISPIGOLO*
◆ 1,4x60 (3/64"x24") RT 9 mm



ANGOLARE COPRISPIGOLO*
◆ 1,4x1,4 (3/64"x3/64") RT 9 mm

* Disponibile in tutti i colori (no Palladiana),
tagliato dal fondo / Available in all colours
(no Palladiana), cut from floor tile

6

PEZZI SPECIALI/ TRIMS



BATTISCOPA
●◆ 4,6x120 (1^{13/16}"x48") RT 9 mm
●◆ 7x80 (2^{3/4}"x32") RT 9 mm

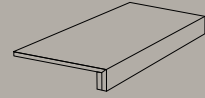

SCALINO INCOLLATO
●◆ 33x60 (13"x24") RT 9 mm



ANGOLARE INCOLLATO
●◆ 33x33 (13"x13") RT 9 mm

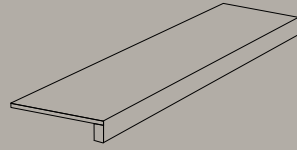

SCALINO INCOLLATO
●◆ 33x120 (13"x48") RT 9 mm

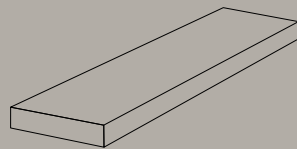

ANGOLARE INCOLLATO
●◆ 33x120 (13"x48") RT 9 mm

SCHEMI DI POSA/ LAYING SYSTEM

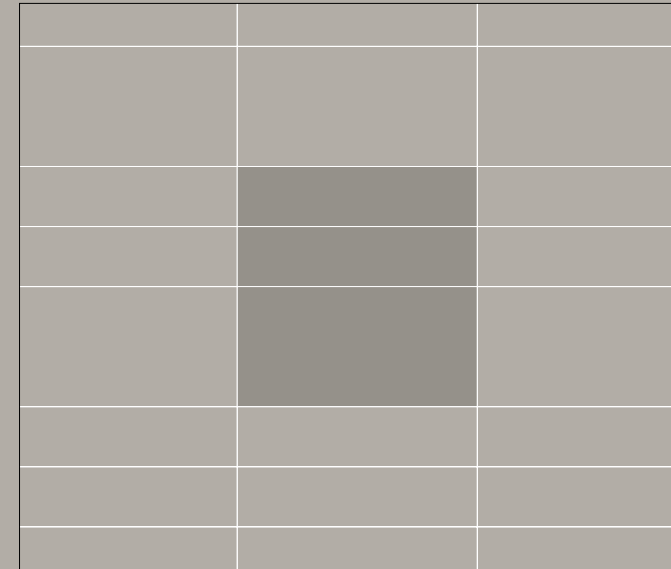

30x120 (12"x48") RT - 50,00%
60x120 (24"x48") RT - 50,00%

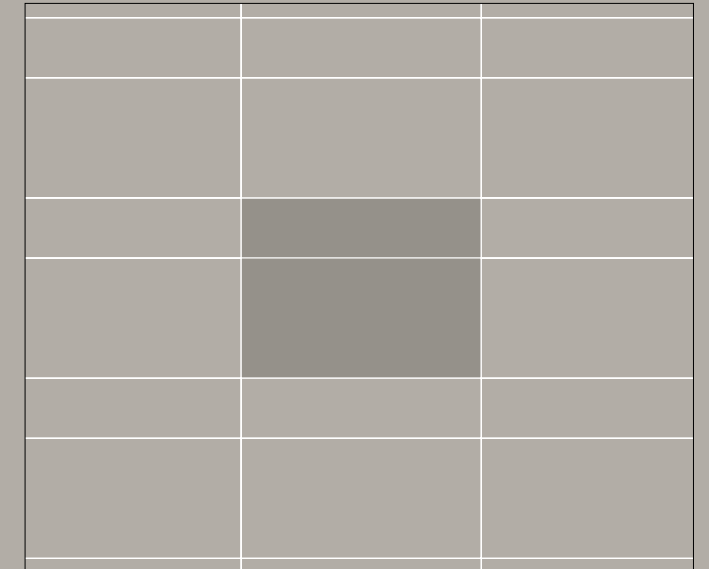

30x120 (12"x48") RT - 33,33%
60x120 (24"x48") RT - 66,66%

● Natural R9 | ◆ Lappato

Fuga minima consigliata per posa in interno 2 mm, in esterno 4 mm
Minimum suggested joint for indoor laying 2 mm, for outdoor 4 mm
Consigli di posa, pulizia e manutenzione al link keope.com
Consigli di posa, pulizia e manutenzione al link keope.com

2
FINITURE/
FINISHINGS



FORMATI / SIZES

	120x278 (119,5x278)* 48"x110"	80x160 32"x64"	120x120 (119,5x119,5)* 48"x48"	60x120 24"x48"	30x120 12"x48"	80x80 32"x32"	60x60 24"x24"
working size	1194x2778	797x1596	1194x1194	596x1195	297x1195	797x797	596x596
	RT	RT	RT	RT	RT	RT	RT
	6 mm	9 mm	9 mm	9 mm	9 mm	9 mm	9 mm
BRECCIA TORTONA	◆	◆	◆	●◆	◆	●◆	
RENOIR ISOLA	◆	◆	◆	●◆	◆	●◆	
CALACATTA SAN BABILA	◆	◆	◆	●◆	◆	●◆	
CARNICO BRERA	◆	◆	◆	●◆	◆	●◆	
PALLADIANA DARK			◆				◆
PALLADIANA LIGHT			◆				◆

*Formato nominale / Nominal size

● Natural R9 | ◆ Lappato

MISURE, PESI ED IMBALLI / SIZE, WEIGHT AND PACKAGING

FORMATO SIZE	SPESSORE THICKNESS	PZ/SCATOLA PIECES/BOX	MQ/SCATOLA SQM/BOX	KG/SCATOLA KG/BOX	MQ/PALLET SQM/PALLET	KG/PALLET KG/PALLET	SCATOLA/PALLET BOX/PALLET
120x278	6 mm	1	3,32	49,37	59,80	988,66	18
80x160	9 mm	2	2,56	51,20	40,96	832,20	16
120x120	9 mm	2	2,86	60,80	57,12	1.229,00	20
60x120	9 mm	2	1,44	31,93	50,40	1.130,55	35
30x120	9 mm	4	1,44	31,48	51,84	1.146,28	36
80x80	9 mm	2	1,28	25,60	53,76	1.088,20	42
60x60	9 mm	3	1,08	25,00	43,20	1.013,00	40

INFORMAZIONI TECNICHE / TECHNICAL FEATURES

INFORMAZIONI TECNICHE TECHNICAL FEATURES	NORMA NORM EN 14411 - ISO 13006	REQUISITI PRESCRITTI REQUIRED VALUES	VALORI VALUES			
 DIMENSIONI RETTIFICATO SIZES RECTIFIED	UNI EN ISO 10545-2	lunghezza-larghezza / length-width $\pm 0,3\%$ ($\pm 1,0$ mm max) spessore / thickness $\pm 5,0\%$ ($\pm 0,5$ mm max) ortogonalità / rectangularity $\pm 0,3\%$ ($\pm 1,5$ mm max) rettilinearità / straightness $\pm 0,3\%$ ($\pm 0,8$ mm max) planarità / flatness $\pm 0,4\%$ ($\pm 1,8$ mm max) qualità superficie / surface quality $\geq 95\%$	CONFORME COMPLIANT			
 ASSORBIMENTO ACQUA WATER ABSORPTION	UNI EN ISO 10545-3	$\leq 0,5\%$	$\leq 0,1\%$			
 RESISTENZA A ROTTURA BREAKING STRENGTH	UNI EN ISO 10545-4	$R \geq 35$ N/mm ² $S \geq 700$ N (<7,5 mm) $S \geq 1300$ N ($\geq 7,5$ mm)	6 - 9 mm CONFORME COMPLIANT			
 RES. ABRASIONE PROFONDA (UGL - Matt) DEEP ABRASION RESISTANCE (UGL - Matt)	UNI EN ISO 10545-6	≤ 175 mm ³	≤ 150 mm ³			
 RES. ABRASIONE SUPERFICIALE (GL - Lappato) SURFACE ABRASION RESISTANCE (GL - Lappato)	UNI EN ISO 10545-6	dichiarare un valore / declare a value	TEST DISPONIBILE TEST AVAILABLE			
 RESISTENZA SHOCK TERMICI THERMAL SHOCK RESISTANCE	UNI EN ISO 10545-9	resistenza / resistant	CONFORME COMPLIANT			
 RESISTENZA AL GELO FROST RESISTANCE	UNI EN ISO 10545-12	resistenza / resistant	CONFORME COMPLIANT			
 RESISTENZA CHIMICA CHEMICAL RESISTANCE	UNI EN ISO 10545-13	resistenza / resistant	CONFORME COMPLIANT			
 RESISTENZA ALLE MACCHIE RESISTANCE TO STAINS	UNI EN ISO 10545-14	pulibile / cleanable	CONFORME COMPLIANT			
	DIN 51130	R	prodotto / product	R	A+B+C	>0,40 >0,42
	DIN 51097	A+B+C	120x278 Lappato - 80x160 Lappato - 120x120 Lappato - 60x120 Lappato - 30x120 Lappato - 80x80 Lappato - 60x60 Lappato	-	-	-
 CLASSIFICAZIONE ALTISDRUCCIOLO ASSESSMENT OF SLIP RESISTANCE	B.C.R.A. (COF)	>0,40 bagnato / wet				
	ANSI A137.1 2012 (DCOF)	>0,42 bagnato / wet	60x120 - 80x80	R9	A	CONFORME COMPLIANT
	Pendulum Test Value PTV 96 (R10)	> 36	-			

Piastrelle pressate a secco - Conforme alla norma EN 14411 e ISO 13006 appendice G gruppo B1-a con E $\leq 0,5\%$
Dry pressed tiles - Compliant with standards EN 14411 and ISO 13006 annex G group B1-a with E $\leq 0,5\%$



HEADQUARTER via statale 467, 21
42013 Casalgrande (RE) - Italy
FACTORY via canale, 67
42013 Casalgrande (RE) - Italy
WAREHOUSE via dell'industria, 1
42013 Casalgrande (RE) - Italy

PHONE +39 0522 997511
FAX +39 0522 997544 (OT) - 545 (IT)
ADMIN. FAX +39 0522 997413

info@keope.com
keope.com

IT_
Ceramiche Keope si riserva la facoltà di apportare variazioni ai prodotti illustrati in questo catalogo per necessità produttive o al fine di migliorarne la qualità. I campioni sono puramente indicativi. Gli imballaggi e pesi riportati possono variare per necessità produttive. Consultare gli uffici commerciali al momento dell'ordine.

EN_
Ceramiche Keope reserves the right to vary the products illustrated in this catalogue for production purposes or in order to improve quality. Samples are purely indicative. Packaging and weights shown may be varied in line with production requirements. Check with the sales department at the time of order.

